

EVSEDO-AC011K-AE-25

User Guide

01.01.002.2023/06-en



This document contains general descriptions and/or general technical specifications of the products mentioned. It cannot be used to determine the suitability or reliability of these products for specific user applications. It is the responsibility of each user or integrator to conduct the appropriate risk analysis in full, assessing and testing products as regards the application in which they will be used and the execution of this application. Neither IPC2U, EVSEDO nor any of its affiliated companies or subsidiaries can be held responsible for incorrect use of the information contained in this document. If you have any suggestions for improvements or correction, or have found errors in this publication, please notify us.

No part of this document may be reproduced in any form or by any means, electronic or mechanical, including photocopying, without express written permission from IPC2U GmbH.

All relevant state, regional, and local safety regulations must be observed when installing and using this product. For reasons of safety and to ensure compliance with documented system data, only the manufacturer should perform repairs to components.

When equipment is used for applications with technical safety requirements, follow the relevant instructions.

Failure to follow this instruction can result in injury or equipment damage.

Table of Contents

1.	Safety Information	4
1.1.	Important Information	4
	HAZARD CATEGORIES AND SPECIAL SYMBOLS.....	4
	IMPORTANT NOTE	4
	SAFETY INFORMATION	4
2.	About This Manual.....	5
2.1.	Aim of This Document.....	5
2.2.	Area of Application	5
2.3.	Related Documents.....	5
3.	Overview	6
3.1.	Introduction	6
3.2.	Description of the Charging Station	6
3.3.	Storing the charging cable.	7
4.	Using	8
4.1.	Starting Charging.....	8
4.2.	Charging Station States.....	9
4.3.	End of Charging.....	10
4.4.	Stopping/restarting charging	10
4.5.	Stopping charging automatically.....	10
5.	Characteristics.....	11
5.1.	Conformity	11
6.	Care.....	12
6.1.	Cleaning the Charging Station.....	12
7.	Malfunctions	12
7.1.	Intervention	12
8.	Protecting the Environment.....	13
8.1.	Recycling Packaging	13
8.2.	End-of-Life Recycling.....	13
9.	Troubleshooting.....	14
9.1.	Fault Resolution	14

1. Safety Information

1.1. Important Information

HAZARD CATEGORIES AND SPECIAL SYMBOLS



Read these instructions carefully, and look at the equipment to become familiar with the device before trying to install, operate, or maintain it. The following special messages may appear throughout this documentation or on the equipment to warn of potential hazards or to call attention to information that clarifies or simplifies a procedure.



The addition of one of these symbols to a Danger safety label on a device indicates that an electrical hazard exists, which could result in death or personal injury if the instructions are not followed.



This is the safety alert symbol. It warns you of a risk of physical injury. You must comply strictly with the safety instructions associated with this symbol to avoid injuring yourself or putting your life in danger.

	DANGER indicates an imminently hazardous situation, which, if not avoided, will result in death or serious injury.
	WARNING indicates a potentially hazardous situation which could result in death or serious injury.
	CAUTION indicates a potentially hazardous situation which could result in minor or moderate injury.
NOTICE	NOTICE indicates practices that do not involve the risk of bodily injury.

IMPORTANT NOTE

Electrical equipment should be installed, serviced, and maintained only by qualified personnel. No responsibility is assumed by IPC2U for any consequences arising out of the use of this documentation.

A qualified person is one who has skills and knowledge related to the construction and operation of electrical equipment and installations, and has undertaken safety training in order to recognize and avoid the hazards involved.

SAFETY INFORMATION

This charging station should not be used by anyone (including children) with reduced physical, sensory or mental capacity, or anyone lacking in experience or knowledge, unless they are provided with supervision or prior instruction in how to use the equipment by the person responsible for their safety.

The EVSEDO range of charging stations is designed exclusively for charging electric vehicles.

This equipment cannot be used to switch on/off the site ventilation at the vehicle's request.

2. About This Manual

2.1. Aim of This Document

The purpose of this user guide is to provide you with the necessary information to charge your electric vehicle using an EVSEDO charging station.

Before using this equipment, read this user guide carefully and retain it so you can consult it at a later date.

2.2. Area of Application

This user guide applies to the following charging stations:

Catalog Number	Supply Type	Power Supply Voltage	Maximum Charging Power	Maximum Charging Current	Connector Type
EVSEDO-AC011K-AE-25	3 Phase	400V AC	11 kW at 400V AC	16 A	T2

2.3. Related Documents

You can download this user manual and other technical documents from our website:

www.evsedo.de

www.evsedo.com

3. Overview

3.1. Introduction

EVSEDO-AC011K-AE-25 is an AC charging station that you can use to supply electricity to an EV. The EVSEDO charging station offers tailor-made, intelligent and network charging solutions for your company or home. The EVSEDO charging station can connect to the internet via WiFi. Charging starts and stops by RFID card or via app, when your vehicle is connected to EVSEDO-AC011K-AE-25 charging station. The EVSEDO charging station is intended for the AC charging of electro vehicles. The charging station is intended for indoor or outdoor use. The charging station AC input is intended for a hardwired installation that complies with the applicable national regulations.

3.2. Description of the Charging Station

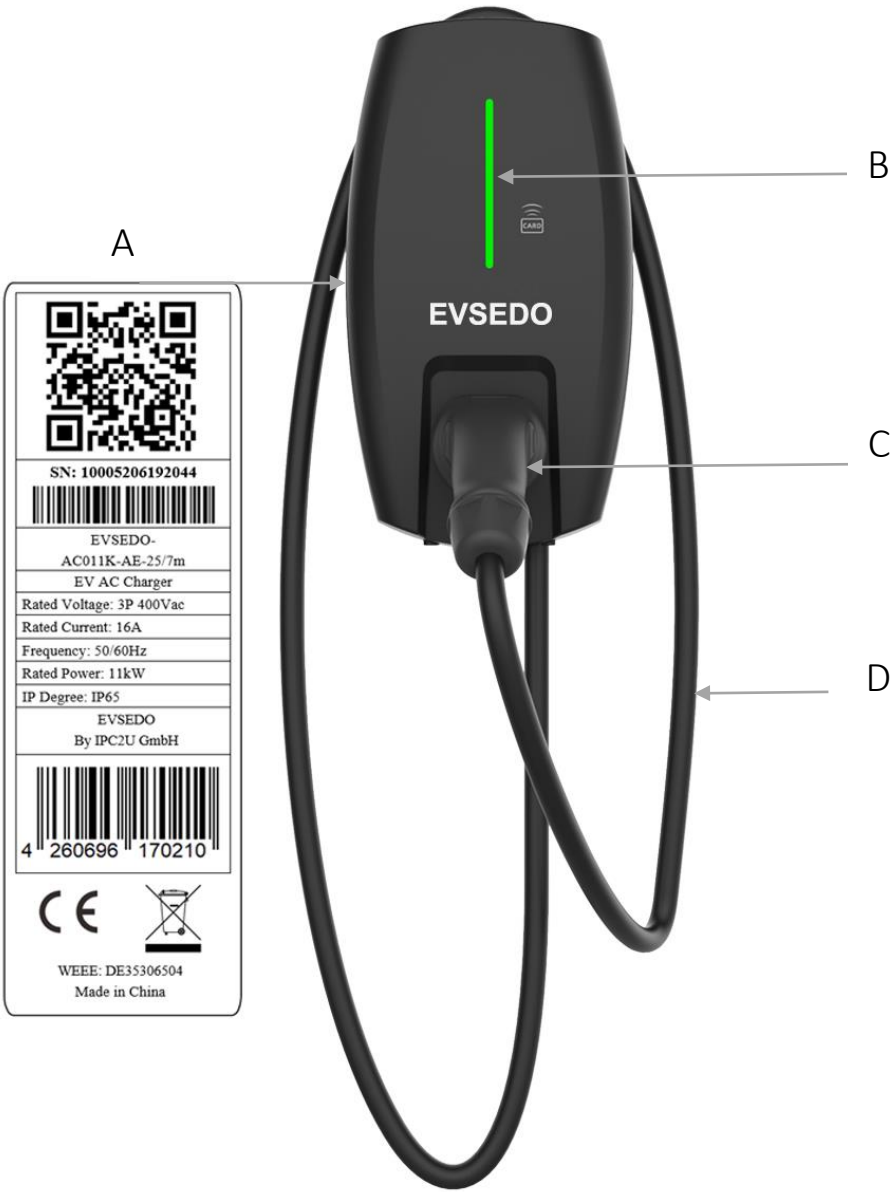

A - Product identification label	C - T2 connector
B - Status indicator light	D - Charging cable

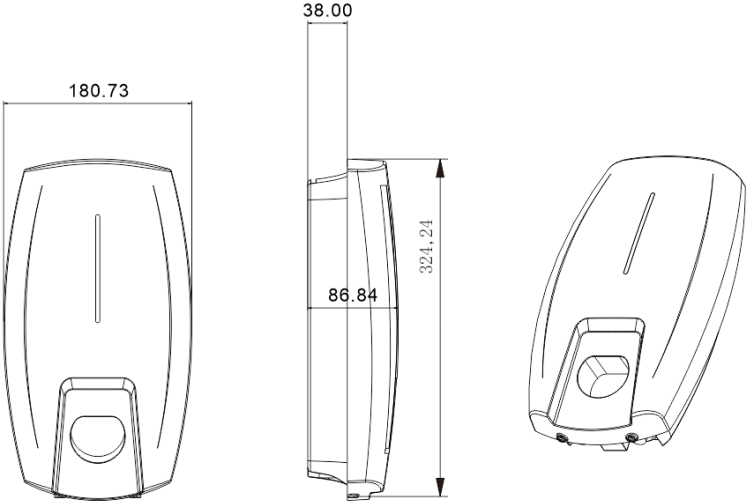
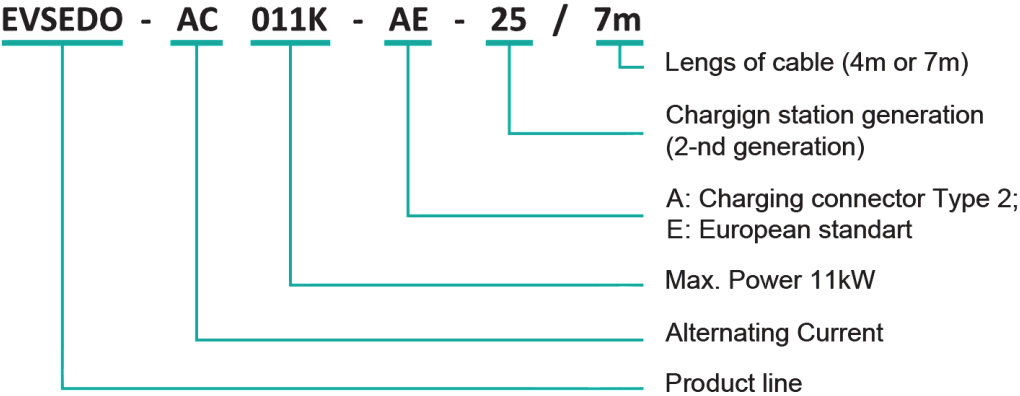

3.3. Storing the charging cable.

When not being used for charging, the cable must be stored as shown in the figure below.

The cable connector should be placed in the connector holder.



4. Using

⚠ DANGER

HAZARD OF ELECTRIC SHOCK, EXPLOSION, OR ARC FLASH

- Do not use **EVSEDO-AC011K-AE-25** if it appears to be damaged or if the charging cable appears to be damaged.
- Do not attempt to touch the cable connector contacts, nor introduce any objects.
- Never plug the charging cable into a multiple socket or an extension cable.
- Do not modify the charging station installation.
- Do not wash the electric vehicle while it is charging.

Failure to follow these instructions will result in death or serious injury.

⚠ WARNING

FIRE HAZARDS

- Do not charge the vehicle if there is any water, evidence of corrosion or foreign bodies in the charging cable connector.
- Do not dismantle or modify the charging cable.

Failure to follow these instructions may result in death, serious injury or equipment damage.

NOTICE

RISK OF DAMAGE TO THE CABLE

Unroll the charging cable to prevent it from overheating.

Failure to follow these instructions can result in equipment damage.

4.1. Starting Charging.

- Prepare your vehicle for charging as per the manufacturer's instructions.
- Check that the charging station status indicator light is flashing green.
- Connect the vehicle to the charging station using the charging cable.
- Check that the charging station status indicator light is flashing yellow.
- Scan the RFID card near status indicator light on the front panel, for starting charging process. Charging process can be also start and controlled via mobile application Evchargeo.
- The start of charging can be postponed at the vehicle's request.
- Charging can be interrupted and restarted at any time by scanning **the RFID card**.
- The indicator light blinks green as soon as charging starts (which can be postponed by the vehicle).
- When the EV is fully charged, the charging will stop

4.2. Charging Station States

The indicator light on the front panel indicates the charging station status:

State	Description	LED Status
In the standby	Normal	Flashing green, 1S on, 4S off
Charging status	Normal	Breathing green, 1S on, 1S off
Plugged gun state	Normal	Breathing yellow, 1S on, 1S off
Software upgrade	Normal	Green light flash
Ground warning	Normal	Flashing yellow, 2S on, 2S off
Relay adhesion	Fault	Red light normally on
Input polarity reverse	Fault	Flashing red, 500ms on, 500ms off, 1 time, 3S off, Cycle
CP fault	Fault	Flashing red, 500ms on, 500ms off, 2 times, 3S off, Cycle
Leakage current fault	Fault	Flashing red, 500ms on, 500ms off, 3 times, 3S off, Cycle
Input terminal overtemperature	Fault	Flashing red, 500ms on, 500ms off, 4 times, 3S off, Cycle
Relay overtemperature	Fault	Flashing red, 500ms on, 500ms off, 5 times, 3S off, Cycle
Under voltage fault	Fault	Flashing red, 500ms on, 500ms off, 6 times, 3S off, Cycle
Over voltage fault	Fault	Flashing red, 500ms on, 500ms off, 7 times, 3S off, Cycle
Overload fault	Fault	Flashing red, 500ms on, 500ms off, 8 times, 3S off, Cycle
Over frequency fault	Fault	Flashing red, 500ms on, 500ms off, 9 times, 3S off, Cycle
Owe frequency fault	Fault	Flashing red, 500ms on, 500ms off, 10 times, 3S off, Cycle
Leakage current loop abnormal	Fault	Flashing red, 500ms on, 500ms off, 11 times, 3S off, Cycle

4.3. End of Charging

⚠ DANGER

HAZARD OF ELECTRIC SHOCK, EXPLOSION, OR ARC FLASH

- Unplug the cable at the vehicle end.
- Place the protective cap on the cable connector (see illustrations below).
- Do not leave the cable on the floor.

Failure to follow these instructions will result in death or serious injury.

NOTICE

RISK OF DAMAGE TO THE CABLE

Do not attempt to unplug the connector without first stopping charging.

Failure to follow these instructions can result in equipment damage.

4.4. Stopping/restarting charging

Charging can be interrupted at any time.

- Scan the RFID card near status indicator light on the front panel, for stopping charging process
- The indicator light turns yellow.
- Charging stops. The cable can then be unplugged. To restart charging, Scan the RFID card again. The indicator light will blink green again.
- Unplug the charging cable.
- The indicator light turns green (standby status).
- Place the charging cable connector into holder on the front panel.
- Wind the cable around the charging station. The charging cable connector should be placed into holder on the front panel.

4.5. Stopping charging automatically

- Once the battery is charged, charging stops automatically.
- Unplug the charging cable.
- Wind the cable around the charging station. The charging cable connector should be placed into holder on the front panel.

5. Characteristics

	Model No.	EVSEDO-AC011K-AE-25/4m	EVSEDO-AC011K-AE-25/7m
Configuration	User Interface	LED indicator, RFID card reader	LED indicator, RFID card reader
	Housing Material	Plastic	Plastic
	Installation Way	Wall-mount (default), Floor-stand (optional)	Wall-mount (default), Floor-stand (optional)
	Card Quantity	2pcs	2pcs
	Charging Outlet	Type 2	Type 2
		4 m	7 m
	Product Dimension	325*181*87mm (L*W*H)	325*181*87mm (L*W*H)
	Net Weight	3.01KG	3.5KG
	Gross Weight	3.83KG	4.5KG
Electrical Parameter	Input Voltage	AC400V±20%	AC400V±20%
	Input Frequency	50/60Hz	50/60Hz
	Max Power	11kW	11kW
	Output Voltage	AC400V±20%	AC400V±20%
	Max Output Current	32A	32A
	RCD	6mA DC	6mA DC
	Standby Power	<3W	<3W
Environmental Index	Application Place	Indoor / Outdoor	Indoor / Outdoor
	Working Temp	-30°C ~ +55°C	-30°C ~ +55°C
	Working Humidity	5% ~ 95% without condensation	5% ~ 95% without condensation
	Working Altitude	<2000m	<2000m
	Protection Grade	IP65	IP65
	Cooling Method	Natural air cooling	Natural air cooling
	Safety Standard	EN 61851-1: 2011, EN 61851-22: 2002	EN 61851-1: 2011, EN 61851-22: 2002
	MTBF	100,000 hours	100,000 hours
	Protections from over voltage, under voltage, over load, current leakage, ground fault, over temperature, under temperature.		
	Charger v.s. Backend communication: WiFi Internet Communication Protocol: OCPP 1.6		

5.1. Conformity

- Declaration of conformity 
- Complies with IEC 61851, Electric vehicle conductive charging system (IEC 61851-1 Edition 2.0 and IEC 61851-22 Edition 1.0).
- Complies with IEC 62196, Plugs, socket-outlets, vehicle couplers and vehicle inlets - Electric vehicle conductive charging system (IEC 62196-1 Edition 2.0 and IEC 62196-2 Edition 1.0).

6. Care

⚠ DANGER

HAZARD OF ELECTRIC SHOCK, EXPLOSION, OR ARC FLASH

- Do not spray water on **EVSEDO-AC011K-AE-25** charging station with a pressure washer.
- Do not clean charging station while the electric vehicle is charging.

Failure to follow these instructions will result in death or serious injury.

6.1. Cleaning the Charging Station

Do not use any aggressive cleaners (e.g. benzene solvents, acetone, ethanol, spirit glass cleaner) to clean the Wallbox and especially the plastic panel. These can attack/damage the surface. Never use abrasive pads or detergents.

Permissible cleaners are mild detergent solutions (rinsing solution, neutral cleaner) and a soft, moistened cloth. We recommend cleaning the charging station with a soft dry cloth.

7. Malfunctions

7.1. Intervention

⚠ DANGER

HAZARD OF ELECTRIC SHOCK, EXPLOSION, OR ARC FLASH

- Do not attempt to open the charging station cover.
- Do not attempt to repair or replace the charging cable.

Failure to follow these instructions will result in death or serious injury.

This charging station contains no user-repairable or user-serviceable parts. Any work on your charging station must only be undertaken by a qualified person.

1. The indicator light blinks red when an abnormal situation is detected.
2. Cut the power to the charging station: in the switchboard, set the dedicated charging station circuit breaker to OFF.
3. Unplug the charging cable.
4. Plug the charging cable back in. The connector must be fully inserted.
5. Power up the charging station: reset the dedicated charging station circuit breaker to ON.
6. If the indicator light does not turn back to green, contact your electrician.

When you contact your electrician, give the full reference for your equipment (model, catalog number, serial number). This information can be found on the sticker attached to the side of the equipment.

8. Protecting the Environment

8.1. Recycling Packaging

The packaging materials from this equipment can be recycled. Please help protect the environment by recycling them in appropriate containers. Thank you for playing your part in protecting the environment.

8.2. End-of-Life Recycling

Products in the EVSEDO model-range have been optimized to reduce the amount of waste produced at the end of their useful life and for better recovery of component parts and materials when following customary processing procedures. Products have been designed so that their components can be processed by conventional procedures: decontamination where this is recommended, reuse and/or dismantling in order to improve recycling performance, and crushing to separate out the rest of the materials.

9. Troubleshooting

9.1. Fault Resolution

Error Code	Problems	Possible Causes	
OverVolt	Input over voltage	AC input voltage may be too high.	<ol style="list-style-type: none"> 1. Check the input voltage from the backend. 2. If the voltage is over 276Vac for a short time, wait till the power grid recovers to normal voltage range.
UnderVolt	Input lower voltage	AC input voltage may be too low.	<ol style="list-style-type: none"> 1. Check the input voltage from the backend. 2. If the voltage is under 184Vac for a short time, wait till the power grid recovers to normal voltage range.
OverCurr	Output overload	AC output current may be too large.	<ol style="list-style-type: none"> 1. Shut off the leakage current protection switch of power distribution cabinet immediately. 2. Check whether there is low resistance connection between AC output cables of the charger.
OverFreq	Input over frequency	AC input frequency may be too high.	<ol style="list-style-type: none"> 1. Check the input voltage frequency from the backend. 2. If the frequency exceeds 63Hz for a short time, wait till power grid recover to normal voltage range.
UnderFreq	Input lower frequency	AC input frequency may be too low.	<ol style="list-style-type: none"> 1. Check the input voltage frequency from the backend. 2. If the frequency is lower than 47Hz for short time, wait till power grid recover to normal voltage range.
OverTemp	Over temperature	Temperature may be too low inside the charger.	<ol style="list-style-type: none"> 1. Check the surrounding conditions of chargers installed whether there is heating device nearby. Make sure environmental temperature is under 60°C.
Over DCLeak	Over leakage current	Leakage current to the earth may be too high.	<ol style="list-style-type: none"> 1. Shut off the leakage current protection switch of power distribution cabinet immediately. 2. Check whether there is broken of AC output cables or low resistance connection to the earth.
PhaseError	Reverse connection	Reverse connection of L/N input cable.	<ol style="list-style-type: none"> 1. Shut off the leakage current protection switch of power distribution cabinet immediately. 2. Check if AC input/output cables are normal, and if inverse connection of L/N input cables.
CableRCError	Charging cable connection abnormal	Poor connection of charging cable with EV/Charger.	<ol style="list-style-type: none"> 1. Check if charging cable connection is correct and firm.

Note: If the above problems cannot be solved, please contact the seller.

